

# Quick Guide

CK-10, CT-10, CP-10, CK-20, CT-20, CP-20,  
CP-30, CP-50, CK-60, CT-60, CP-60, CP-100 & CP-200





Designed and Manufactured  
in the United Kingdom



## Operating your Security System

This quick guide covers the everyday operation of your alarm system, for full details on system operation and programming, please refer to the 'Master User Guide'.

### Full Arming Your Security System

Enter your code or present tag to access the user menu, then scroll down to 'Full Arm System' and press  or . The exit tone will sound and the keypad will instruct you to exit the protected area.

### Part Arming your Security System (Part Arm 1)







Enter your code or present your tag to access the user menu, then scroll down to the required Part Arm e.g. 'Part Arm 1'. Once the required part set has been highlighted press  or  to confirm. The exit tone will sound, and the keypad will instruct you to exit the protected area.

NOTE! Part sets will only be displayed if programmed by the installation company.



### Disarming your security system

Enter the premises or protected area via the designated entry point. The entry tone will sound, proceed directly to the keypad and present your tag. The entry tone will stop and the system is disarmed.













### Area full arming

Enter your code or present tag to access the user menu, then scroll down to 'Area Full Arm'. Then use the  /  and  /  keys to toggle the selected area on or off. Once you have selected the areas that you would like to arm, press  or  to confirm. The exit tone will sound and the keypad will instruct you to exit the protected area.





### Resetting after an alarm or Fault

Enter your code or present tag to silence any internal and external sounders. The reason for the alarm or fault will then be displayed on the keypad screen. Enter your code or present the tag again, then scroll down to the 'Reset Alarms' option and press  or .





### Omitting Zones

Enter your code or present tag to access the user menu, then scroll down to the 'Omit Zones' option and press  or . Use the  /  and  /  keys to select the required zone then use the  /  and  /  keys to turn omit on or off. When you've finished omitting the zone(s), press the  /  or press and hold the  key for 2 seconds to return to the user menu. If required, the system can be armed or part armed with selected zone(s) omitted by selecting the relevant arming function key.

### Changing Your Code

Enter your code or present tag to access the user menu, then use the arrow keys to scroll down to the 'Change my code' option. Press  or  to select, now enter your old passcode, if correct you will be prompted for a 'new code'. Enter your new code then press  or .

### Turn chime on/off

Enter your code or present tag to access the user menu, then press and hold the  /  or  key. The area selection menu is displayed, choose the areas you want to chime then press the  or  key.





Function Keys				
Keypad buttons (RK-500's / RK-700's / RK-800's)	Keypad buttons (RK-900's & RK-1000's)	Keypad buttons (RK-400's)	Touch Keypad buttons	Actions
				Arm system
				Part arm system
		-		Area arm system
				Selection button
				Chime tone selection
				Escape button
				Cancel button
-	-	0	-	Toggle options & outputs
-		-	-	*Control an operation e.g. Open Garage Door









\*If programmed by the installation company

Status Icons	
Icon	Indicates
	Battery is charging/ is charged
	Mains power is connected
	Mains power is disconnected
	External strobe is flashing
	External bell is sounding
	Chime is enabled
	WiFi module connected
	GSM module connected
	Ethernet module connected
	Phone line connected
	User programmed timer running
	User programmed alarm running
Keypad Status LED	
Colour	System Status
Blue	Normal operation, all zones are healthy
Green	User menu selected and system is ready for arming
Yellow	One or more zones are active, system may not arm
Red	Alarm active

## Additional Features

Additional features can be enabled by the installation company and as such some options may not be available on your security system.

To access the additional features whilst the system is in an unset state, press  /  and  /  from the home screen and scroll through all enabled additional features:

Feature	Keypad Text	Operation	Touch screen Icon
Control Outputs	User Control	Allows custom programmed outputs to be operated without the requirement of a user code i.e. opening garage doors.	
X10	X10 Control	Allows users to operate X10 outputs without the requirement of a user code. X10 is a home automation solution, this is a 3rd party peripheral that may be connected to the security system.	
Alarm Clock	Alarm Clock	Allows users to program an alarm clock using the control panels keypad. A useful application is for a keypad that is situated in the bedroom, an alarm can sound in the morning to wake the user up.	
Turn Chime on or off	Chime	Allows users to turn chime on or off for selected areas without the requirement of a user code. Chime is commonly used to create a tone when a front door is opened.	
Review voice Messages	Messages	Allows users to listen to voice messages they may have been left through the control panel – the user can play and delete these messages.	
Send a text message	Send SMS	Allows users to send text messages from the control panels PSTN/ GSM module – the user can add a mobile phone number and a 255-character message and send this message.	
Display LCD Message	LCD Message	Allows users to display a text message on the LCD of all keypads.	
Countdown timer	Timer	Allows users to start a countdown timer without the requirement of entering a user code. A common application would be when cooking or for an office complex when the building needs to be closed.	

For Support Telephone: \_\_\_\_\_

© 2022

INS024 23/5/2022

**WISENET**

# **NETWORK VIDEO RECORDER**

**Quick Guide**

PRN-3210B2/PRN-1610B2

XRN-6410RB2/XRN-6410B2/XRN-3210RB2/XRN-3210B2

**CE**

## Features

The product records video and audio from network cameras to a hard disk, and enables playback from the hard disk. It also provides remote monitoring environment for video and audio over the network using a remote computer.

- Provides AI function (Wisenet Non-AI P/X series camera, X Lite excluded)
- Provides AI face recognition function (when using Wisenet AI camera)
- Provides AI vehicle license plate recognition function
- Can be linked to AI camera
- Supports AI search (Person, Face, Vehicle, License Plate)
- Supports BestShot view
- Provides new UI 2.0
- Supports instant viewer
- Bookmark function
- Thumbnail function
- View camera event list in real time
- Convenient event rule setup
- Various sequence (layout, page) functions
- Extended search period
- Convenient log search
- Supports thermal imaging camera/PTZ linked camera
- Supports a range of 4K camera resolutions
- Outputs a 4K high definition image using HDMI
- Supports dual monitor output (expand, duplicate)
- Record and play video
- Record and play audio
- Supports ONVIF Profile S standard and RTP / RTSP protocols
- Display the HDD operation status by HDD SMART
- HDD overwrite enabled
- Function to export using USB memory and external hard disk
- Simultaneous play of 16, 32, 64 channels
- View multi-channel time line when playing videos
- Various Search Modes (Time, Event, Smart, Text, Export, ARB)
- ARB support (configuration feature for saving period by channel)
- Various recording modes (Normal, Event, Scheduled Recording)
- Alarm Input / Output
- Remote monitoring function by Windows Network Viewer
- Live monitoring of the network camera
- Installation Wizard Function (Recorder, Web Viewer)
- Supports the smartphone remote monitoring feature by P2P support
- Provides smartphone event alarm (sending real-time event messages)











Hanwha Technwin Co., Ltd. is a surveillance camera manufacturer that provides video information equipment with various functions. Users must comply with local laws when using our devices. Users are solely responsible for any illegal use of our products.

## Package Contents



- The appearance of the components may differ from the image shown.
- Accessory category and quantity may differ depending on sales region.
- For some regions, HDD is not pre-installed. HDD Fixing Screw, SATA Cable quantity vary depending on the model.

### PRN-3210B2/PRN-1610B2/XRN-6410RB2/XRN-3210RB2

		
Recorder	Mouse	Power Cable
		
Bracket Rack	Quick Guide	Terminal block (2 ea)
		
HDD Fixing Screw (32 ea)	Bracket Fixing Screw (8 ea)	Grounding screw (1 ea)
		
Hard Disk Number Sticker	Front Cover Lock Key	

### CAUTION





- RISK OF EXPLOSION IF BATTERY IS REPLACED BY AN INCORRECT TYPE. DISPOSE OF USED BATTERIES ACCORDING TO THE INSTRUCTIONS.
- Do not ingest battery. Chemical Burn Hazard.
- This product contains a coin / button cell battery. If the coin / button cell battery is swallowed, it can cause severe internal burns in just 2 hours and can lead to death.
- Keep new and used batteries away from children. If the battery compartment does not close securely, stop using the product and keep it away from children. If you think batteries might have been swallowed or placed inside any part of the body, seek immediate medical attention.



### ATTENTION



- ILY A RISQUE D'EXPLOSION SI LA BATTERIE EST REMPLACÉE PAR UNE BATTERIE DE TYPE INCORRECTEMENT AU REBUT. LES BATTERIES USAGÉES CONFORMÉMENT AUX INSTRUCTIONS.
- Ne pas ingérer la pile, risque de brûlure chimique.
- Ce produit contient une pile de type bouton/pièce de monnaie. Si la pile de type bouton/pièce de monnaie est avalée, elle peut causer de graves brûlures internes en seulement 2 heures et peut entraîner la mort.
- Gardez les piles neuves et usagées hors de portée des enfants. Si le compartiment de la pile ne se ferme pas correctement, cessez d'utiliser le produit et gardez-le à l'écart des enfants. Si vous suspectez que des piles ont été avalées ou insérées dans une partie du corps, consultez un médecin sans tarder.

- If you are adding a new or previously used HDD to this product in addition to the HDD(s) originally installed, format the new HDD manually in the set before use. To learn how to format, see "Device/Format" in the User Manual.
- If you wish to replace or add an HDD, contact your dealer or our customer service first.

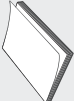

	Recorder
	Bracket Rack
	HDD Fixing Screw (32 ea)
	SATA Data Cable (8 ea)

	Power Cable
	Terminal block (2 ea)
	SATA Power Cable (2 ea)

	Mouse
	Quick Guide
	Bracket Fixing Screw (8 ea)
	Grounding screw (1 ea)

**PRN-3210B2/PRN-1610B2/XRN-6410B2/XRN-3210RB2**

**1** Use the lock key on the front cover to unlock it, and press and pull the left notch of the front cover to separate it.

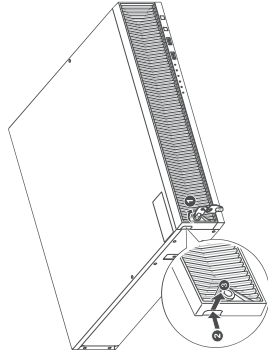

**2** Press the orange button on the hard disk bracket to the left and pull forward to separate the main body and the hard disk bracket.

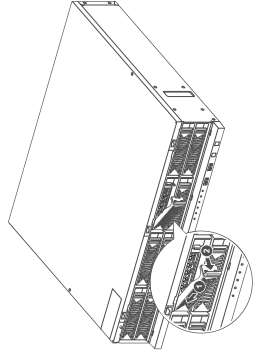

**3** Mount a HDD in the HDD bracket and screw it in using the screws provided.

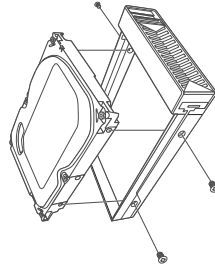

**4** Once the HDD is mounted in the bracket, push the bracket into the main body and close the front cover.

- Fit the front cover into the bottom notch on the recorder, and then press and close until you hear a 'click'.
- Use the front cover lock key to lock the front cover so that it does not get separated.

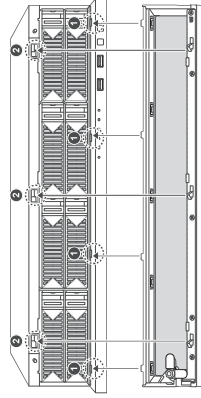

## XRN-6410B2/XRN-3210B2

- 1 Remove the screws from the top and back sides of the recorder, and push the cover back to release it.

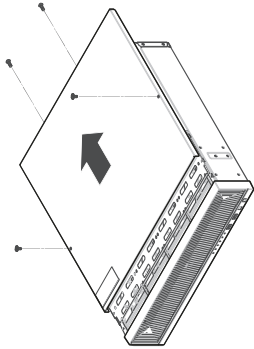

- 2 Remove the screws from the left/right sides and release the bracket.

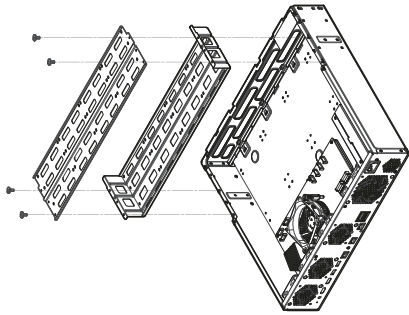

- 3 Mount 8 hard disks into the bracket, and fix it using screws.

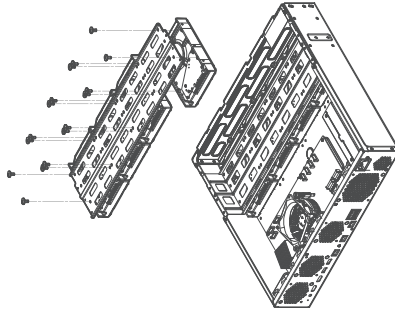

- 4 Fix the hard-disk-mounted bracket to the recorder using screws.

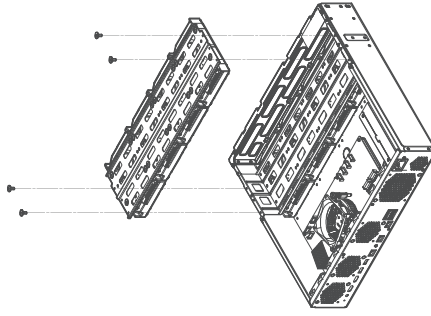

- 5 Connect the SATA/power cable of the hard disk to the connector of the main board.

- Refer to the figure below for the hard disk location number and connector number.

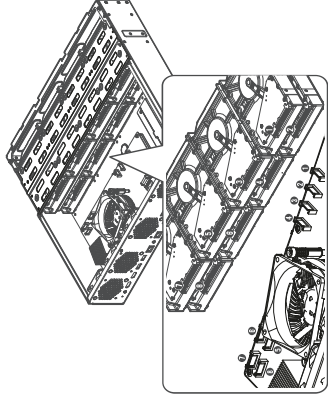

- 6 Make sure that there is no problem in the connection port and routing inside the recorder, and then fix it using screws after closing the cover.
- When closing the cover, be careful not to damage the cable.

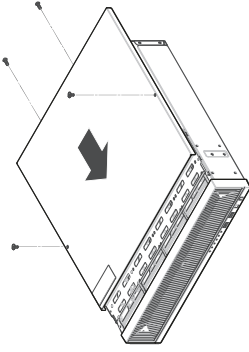

## Connecting the Network



■ For more information about network connection, see "Network Configuration" in the User Manual.

### Network connection via Ethernet (10/100/1000BaseT)

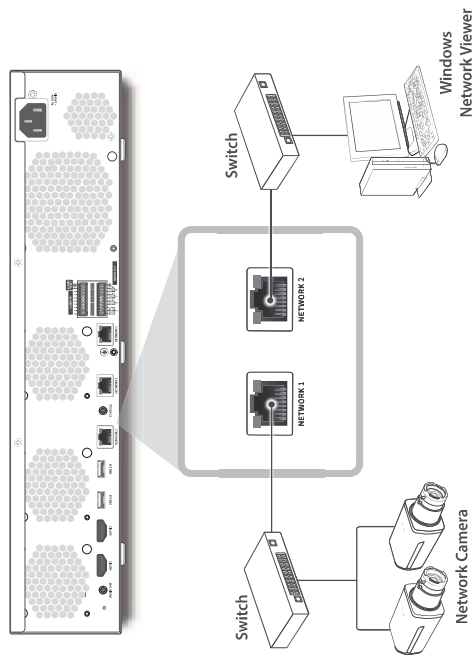

### Network connection via router

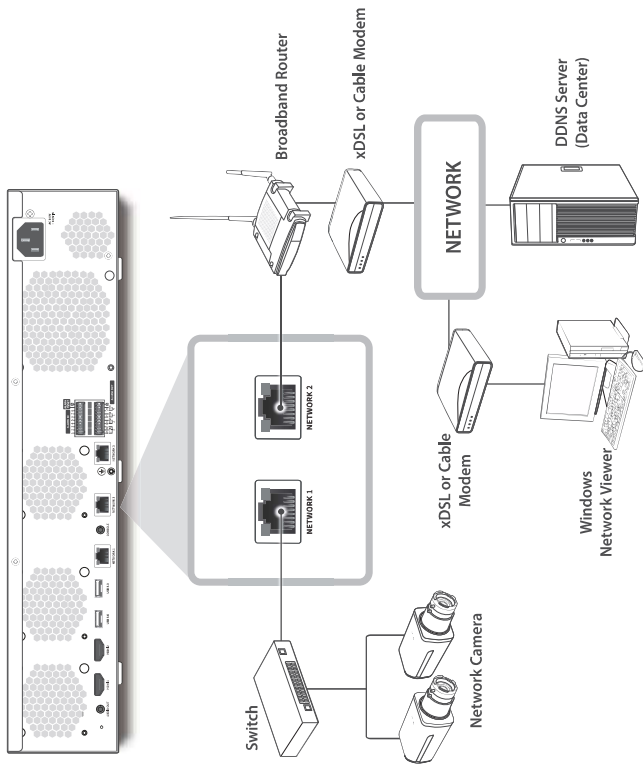

## Installation Wizard Setup

As shown below, proceed through each step of the <Installation wizard>. Install Wizard can only be accessed at factory reset. If you do not want to proceed, click <Exit>.



- You can set the installation wizard on the recorder and web viewer. Refer to the User Manual for instructions on how to set up the installation wizard on the web viewer.
- When you complete installation using the installation wizard on your recorder, the installation wizard will not appear on your web viewer.

### 1 Select the language

Select your preferred language.

Installation wizard

Choose the language to use in the product.  
To continue, click Next.

English  Spanish  Polish  Czech  Turkish  Swedish  Japanese  Vietnamese  Thai

Dutch  FR  Hindi  Indonesian  Italian  Korean  Malay  Russian  Thai  Vietnamese  Chinese

Back Exit

### 2 Network Settings

- DHCP server : If the DHCP server is set to enable, an IP is automatically assigned to the camera.
  - Network 1 (Camera) : Port for camera connections; it receives video from a camera.
  - Network 2 (Viewer) : This is a port for transmitting an image to the webviewer.
  - Network 3 (iSCSI) : This is a port for connecting an external iSCSI.
  - Network 1 / Network 2 / Network 3 Setup
    - IP Type : Choose the network connection method.
    - IP Address, Subnet Mask, Gateway, DNS
  - Enable online upgrade
    - You can receive a new firmware notification when your recorder is connected to a network.
- ※ For more details on network settings, refer to the User manual.
- ▶ To use a simple intranet, click <Next>.

Installation wizard

Check the connection port on the back of the product and set the network of the recorder.  
To set the network, setting to basic, click Next.

DHCP server  Run

Network 1  Run

Network 2  Run

Network 3  Run

When the DHCP server is enabled, the camera IP address is automatically assigned.

Network 1 (Camera)  Run 192.168.2.200

Network 2 (Viewer)  Run 172.30.1.194

Network 3 (iSCSI)  Run 192.168.2.200

Network 1, 2 port is not connected.  
Network 3 port has been connected.

Enable online upgrade

Back Exit

### 3 Recorder ID/PW Setup

Sets the administrator's password.

Installation wizard

Set a recorder password.

ID (Administrator)

Initial Password (XXXXXXXXXX)

Confirm Password (XXXXXXXXXX)

Show password

Back Exit

※ Click < i > to view the basic guide for setting a password. Refer to the password setup rules.

### 4 Camera ID/PW Setup

- 4-1. Set a camera password in factory reset. The initial password for the camera must be entered.
- 4-2. If ID/PW is already set in the camera, register the ID/PW and click <Next>.

Installation wizard

Set the password of the factory default Wisenet camera

Use the recorder administrator ID and password as the camera account

Initial Password (XXXXXXXXXX)

Confirm Password (XXXXXXXXXX)

Show password

Register the camera ID for which the password had been set and the password (up to 3)

Enter the camera ID and password

Back Exit

- ※ Click < i > to view the basic guide for setting a password. Refer to the password setup rules.
- ※ When the password is in factory reset, it can be changed and managed in a batch.
- ※ Up to 3 sets of camera ID with password and password can be registered.
- ※ You may change the passwords of registered cameras all at once in the "Setup > Camera > Camera password" menu.
- ※ You cannot change the password for cameras registered with ONVIF and RTSP.

## 5 Date & Time Setup

Set the date, time, time zone, and DST and then click <Next>.

Installation Wizard

Set the system time of the product.

Date: 2020-11-17 (YYYY-MM-DD)

Time: 13:21:57 (HH:MM:SS)

Time zone: GMT+09:00

Daylight saving time:  (Sun) 1st ~ Oct, last (Sun) 1st

Next < Back

※ The time zone setup might differ depending on the region that the product is released.

## 6 Camera Register

Registers the searched network cameras.

- 6-1 Select a camera to register from the searched camera list and click <Register>.
- 6-2 Select a camera to register from the list and click <Change IP>.
- 6-3 After completing camera register, click <Next>.

Installation Wizard

Number of registered cameras: 0 / 32

Name	IP	Port	Register
1	192.168.1.1	80	Register
2	192.168.1.2	80	Register
3	192.168.1.3	80	Register
4	192.168.1.4	80	Register
5	192.168.1.5	80	Register
6	192.168.1.6	80	Register
7	192.168.1.7	80	Register
8	192.168.1.8	80	Register
9	192.168.1.9	80	Register
10	192.168.1.10	80	Register
11	192.168.1.11	80	Register
12	192.168.1.12	80	Register
13	192.168.1.13	80	Register
14	192.168.1.14	80	Register
15	192.168.1.15	80	Register
16	192.168.1.16	80	Register
17	192.168.1.17	80	Register
18	192.168.1.18	80	Register
19	192.168.1.19	80	Register
20	192.168.1.20	80	Register
21	192.168.1.21	80	Register
22	192.168.1.22	80	Register
23	192.168.1.23	80	Register
24	192.168.1.24	80	Register
25	192.168.1.25	80	Register
26	192.168.1.26	80	Register
27	192.168.1.27	80	Register
28	192.168.1.28	80	Register
29	192.168.1.29	80	Register
30	192.168.1.30	80	Register
31	192.168.1.31	80	Register
32	192.168.1.32	80	Register

Next < Back

## 7 Channel Setting

You can view the camera videos registered to each channel in split mode along with thumbnail information. To change the camera video position, select a video and drag and drop it to the desired location.

Installation Wizard

Next < Back

Finish

8 Click <Finish> to complete the installation wizard.

## Explore Screen Configuration

The recorder screen consists of the following.

- The screen may be configured differently depending on the menu selected by the user.



No.	Screen configuration	Detailed description of function
1	Menu	Clicking on each menu takes you to the corresponding menu screen.
2	List/Event	Select to view list of cameras or events.
3	Camera List	Click  List to display list of registered cameras in the recorder. You can also register the camera manually or automatically.
3	Event List	Click  Event to display list of events.
4	Layout List	This displays a list of the default layouts and the layouts that have been created. You can set and play sequence on the list of layouts.
5	PTZ Control	Controls the connected PTZ camera.
6	Function Buttons	Function that is frequently or urgently used. (export, alarm stop, manual recording, OSD display, channel information, check camera status, auto-switch screen, split mode setting, change aspect ratio, switch to full screen mode)
7	Video Window	Shows the video of the camera connected to the recorder.
8	Display System Status and Additional Functions	<ul style="list-style-type: none"> <li>Displays the status of the system, hard disk, and network.</li> <li>The ID of the connected user is displayed.</li> <li>Displays a QR code to download User Manual.</li> </ul>
9	Display Events and Functions to Control Videos	Displays events that occurred on the camera and functions related to video control.

## Record Setup

You can set resolution, FPS, and quality of recordings by channel, and by recording type of standard / event. You can check frame rates and data transfer amount of Full Frame and Key Frame recordings for each channel, and set the transfer limit for recordings.

### Setup > Record > Record setup

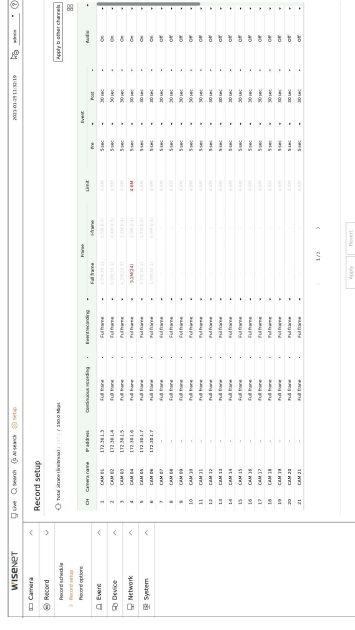

- Apply to other channels : If you select <Apply to other channels>, "Apply to other channels" confirmation window will appear. After selecting channels that the settings will be applied to, click on <OK> to apply them to the selected channels.
  - : The camera of the corresponding channel is displayed on the list or as a thumbnail.
  - Camera name : Displays the camera name.
  - IP Address : Displays the camera IP address.
  - Continuous recording / Event recording : Set the recording method for Continuous recording or Event recording.
    - Full frame : Records all frames fed by the camera.
    - I-frame : Records only key frames fed by the camera. Depends on camera settings.
    - Off : No recording is made.
  - Frame
    - Full frame : Shows the amount of data for all the scene recordings.
    - I-frame : Shows the amount of data for the main scene recordings.
  - Limit : Set the amount of data allowed for input for each channel.
  - Event : When an event occurs, you can set which point you will start or stop recording.
    - Pre : When an event occurs, recording will be started regardless of the time set. If you set it to five seconds, recording will start at five seconds before an event occurs.
    - Post : When an event occurs, recording will continue after the time set. If you set it to five seconds, recording will continue for a further five seconds after an event is finished.
  - Audio : Specify whether to record the sound received from the camera or not.
    - If a channel's data transfer exceeds defined allowed limit, then it may affect to other channels, and may force switching to <I-frame> recording even when the channel is configured to <Full frame> recording mode. For Key Frame recording channels, the icon for limited recording appears on the live screen's top side. But if the sum of the limits is below the max limit, you can still receive the entire frames despite exceeding the permitted bitrates for each channel.
    - A channel displayed in yellow indicates that the recorded data is not being transferred from the camera and that the recording is being performed temporarily using another profile on the camera. Check the channel information to see the applied profile to the channel listed in yellow. A channel displayed in orange indicates that the amount of inputted data is greater than the permitted data amount. In this case, it is impossible to record all of the incoming frames.
- Instead, only part of the frames (1 or 2 frames per second) can be recorded. To resolve this issue, you must set the permitted data amount to be greater than the amount of inputted data.

## Set up and Run the Layout

The layout set on the live screen can also be used for time search and can be searched and played according to the channel order and channel combination set by the user.

- For more information on how to set each step, refer to the 'User Manual'.

### 1 Live channel layout setup

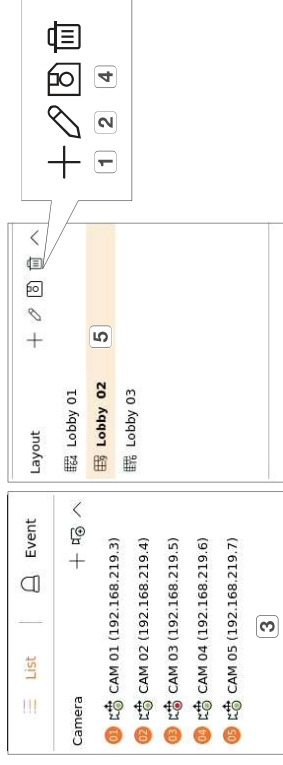

- Add a layout.
- Change layout name. (Example: Lobby 02)
- Click to select the channel to display on the layout of the camera list.
- Please save the layout you have set up.
- Select a layout to move to the corresponding channel group. (Example: Move to Lobby 02).

### 2 Search/Play

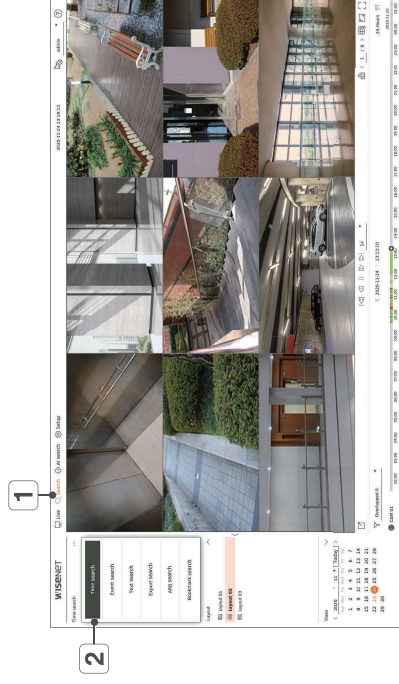

- Click <Search> at the top of the screen.
- Click <Time search>.

### 2-1 Search

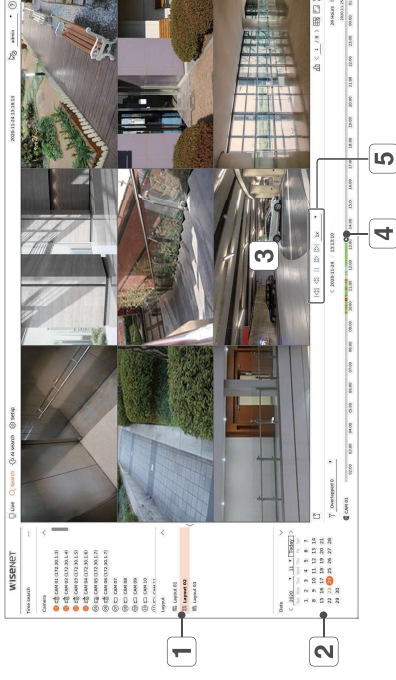

- Select the layout of your choice from the channel groups you created in Live.
- Please select a date to search.
- Select the channel of your choice from the selected channel group.
- You can view the preview screen on figure 3 by moving the time bar.
- Press < > to play the selected channel.

### 2-2 Play

When you start playing, the search date and play time are displayed, and you can search for recorded videos while controlling the play speed.



- Control the play speed or move to the previous or next frame.
- Export the recorded video of a designated time frame for each layout or channel.
- Filter events by type to search for recorded videos.
- Set the overlapping section according to change of time to check the time line.
- Display the time line for each channel.
- Open or close the 4-channel time line.

### 3 Export recorded video

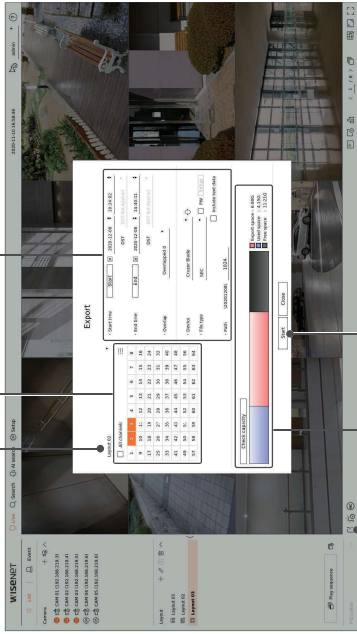

- 1 Click  at the bottom of the screen.
- 2 Select a layout.
- 3 Select a channel.
- 4 Set the time, device, and format for export.
- 5 Click the **<Check capacity>** button to see if you can export.
- 6 Click the **<Start>** button to proceed with the export.

### Using Product Information

You can check the product information/manual/firmware information/FAQ/HDD compatibility list on the homepage or mobile web of your smartphone.

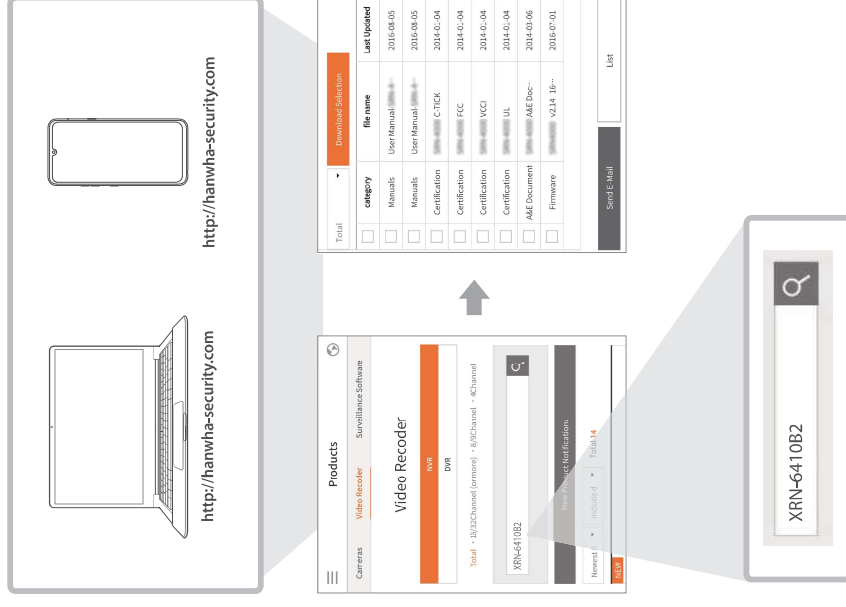

## Using P2P Service

This function is available only for products that support P2P. To find products that support P2P, see 'Products supporting each feature (Page 4)' of the Product Specification Manual.

When using a P2P service, you can easily access and use with Wisenet mobile.

- 1 Click <Enable P2P> to test the connection to see if the current recorder can be connected remotely. The product is displayed on the list.

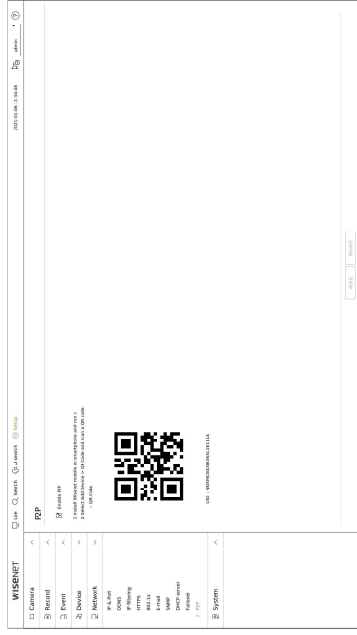

- 2 If the connection is successful, search for Wisenet mobile on your smartphone and install and run it.
  - You can scan the QR code on the recorder by selecting Add device> QR code.

- 3 If you scan the QR code, the device ID shown in the recorder is automatically reflected as the mobile viewer ID. You can use the mobile viewer immediately by entering the ID/password of the recorder.

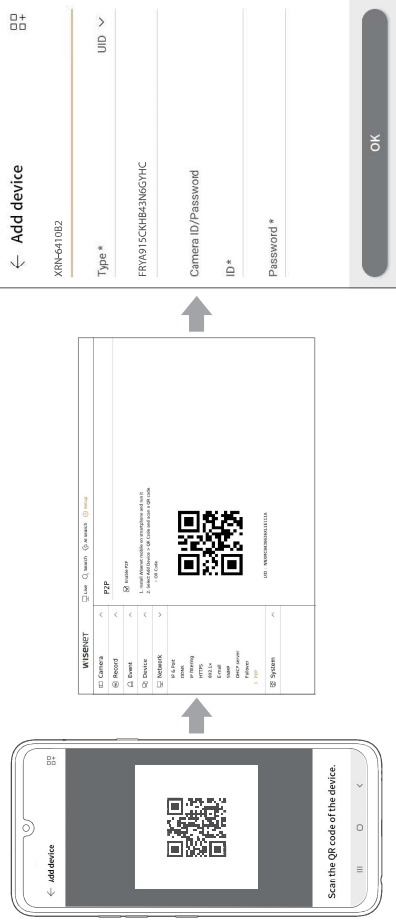

- 4 From now on, when you run the Wisenet mobile application saved to your smartphone, you can easily monitor with your smartphone as you are automatically connected to the recorder.

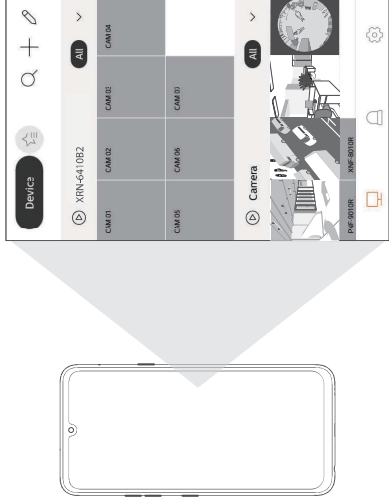

- The P2P service period expires in 3 years. If you want to extend it after expiration, contact your vendor.

## Connecting to a Network Using a Router

If you want to add 1-3 PCs and recorders in an environment using xDSL/Cable modem, you can use the router with only one Internet line.

This guide is an installation guide for network beginners. Follow the instructions to set up your router, local PC, and recorder.

### Connecting the cable

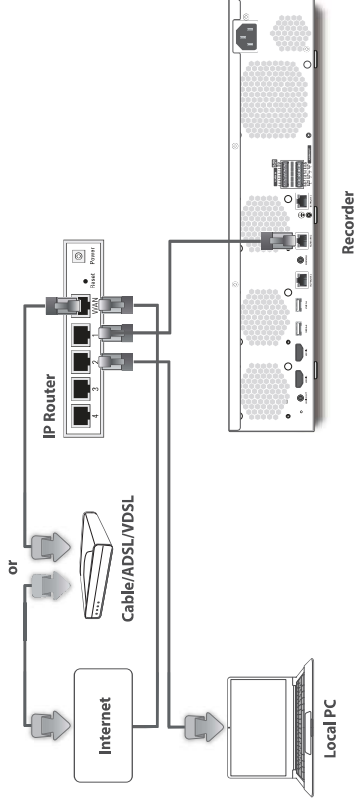

### Connecting a router with PC

- Refer to the router's user manual.

### Connecting a recorder and a router

- Move to **<IP & Port>** of the Recorder **<Network>** Setting menu, and set the **1 <IP address>** and **2 <Gateway>** in **<Setup>**.
- ※ The **<Default gateway>** checked on the **[cmd.exe]** window of the local PC and the **<Gateway>** of the recorder must be the same.
- ※ At least the third number of the recorder **<IP address>** should be set to be the same as the **<Default gateway>** checked on the **[cmd.exe]** window of the local PC.

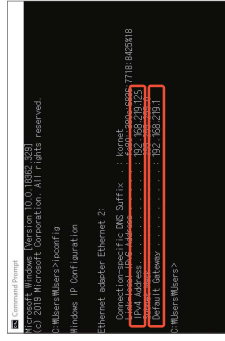

<cmd.screen>

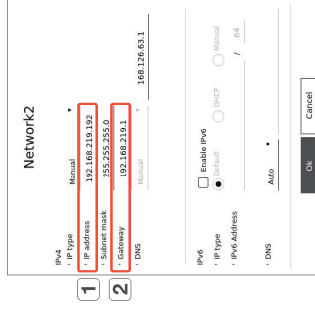

<ex. Recorder screen>

## Checking the recorder connection from the PC

Enter the IP set in the recorder menu in the local PC address bar to go to the web viewer screen of the recorder.



## System requirements

The following lists the minimum suggested hardware and operating system requirements needed to run the Web Viewer.

- Recommended browser : Edge, Chrome
- Supported browsers : Chrome, Edge, and Safari
- Supported OS : Works on all of the Windows, Linux, and OS X environments given the platform-independent nature of the web.
- Tested environments : Tested and certified to run on Windows® 10 with Edge 83, Google Chrome™ 83 and Intel® Core™ i7-7700 processor 3.60 Ghz with NVIDIA® GeForce® GTX™ 1050 or Intel™ HD Graphics 630.
- Performance restrictions : The performance of users' CPU/GPU may impact the video playback performance of the web viewer.

## Router and Internet connection setup

Since each router has a different connection method, check the settings for each router.

### Port forwarding on the router setup

Set up the router's port forwarding to connect to a PC or a recorder connected to the router's local LAN from outside.

The recorder uses the **<RTSP>**, **<HTTP>**, **<HTTPS port>**, and camera proxy ports. You must set up port forwarding for all the ports you use.

- ※ If only **<HTTP>** is set for port forwarding, **<RTSP>**, which is a video transmission port, is connected, but no video is displayed.
- ※ If only **<RTSP>** is set for port forwarding, no connection is available because **<HTTP>**, which is a web connection port, is connected.
- ※ Refer to the router's user manual.

## Accessing using DDNS address in the dynamic IP environment

In the dynamic IP environment such as xDSL/Cable modem, the router's WAN IP can be changed, so we provide DDNS (Dynamic Domain Name Server) service so that you can always access the recorder with only the DDNS address even in the dynamic IP environment.

### Wisenet DDNS Setup

Since you will be accessing the recorder remotely, set up a Wisenet DDNS account first using a PC.

- 1 Open a browser, go to [ddns.hanwha-security.com](http://ddns.hanwha-security.com), and click <Login>.

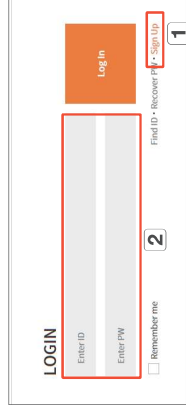

- 1 Follow the instructions to register an account on the website.
- 2 Log in after completing account registration.

- 3 Click <Register Product> tab to add a recorder to your account.

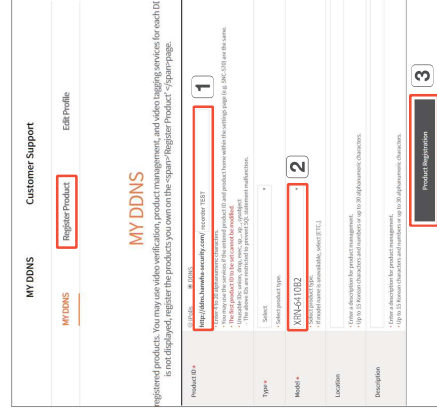

- 1 Create a name for your recorder (product ID).
- 2 Select the type of recorder and model name.
- 3 Click <Product Registration>.

## Connect using DDNS address

- 1 Select DDNS site on the recorder setup menu and enter the product ID.



- 1 Select <ddns.hanwha-security.com> on the <Server> on the <Network> menu.
- 2 Enter the product ID generated on the Wisenet DDNS website for <Product ID>.
- 3 When the DDNS setup is finished, select <Apply>.

- 3 You can connect to the recorder by entering the DDNS host address, <http://ddns.hanwha-security.com/recorder TEST>, on a local PC website address bar.

You can also click < View > in item 2 to connect to the recorder.



- 4 The web viewer screen of the recorder appears.



- 2 Connect to [ddns.hanwha-security.com](http://ddns.hanwha-security.com) and check if the connection status of the registered product is set to <ON>.



All settings are complete.

If you remember your DDNS address and ID / password, you can access the recorder from any PC with an Internet connection.

For more information, refer to the user manual.